

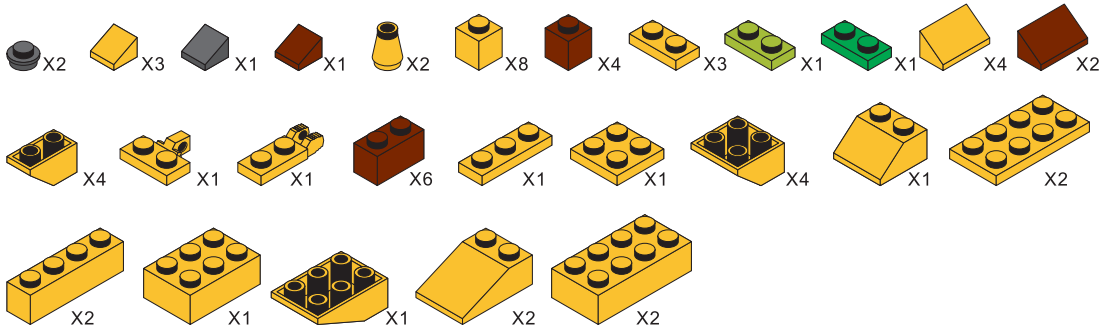

HYBRID - GIRAFFE



REGULAR BRICKS



STAX

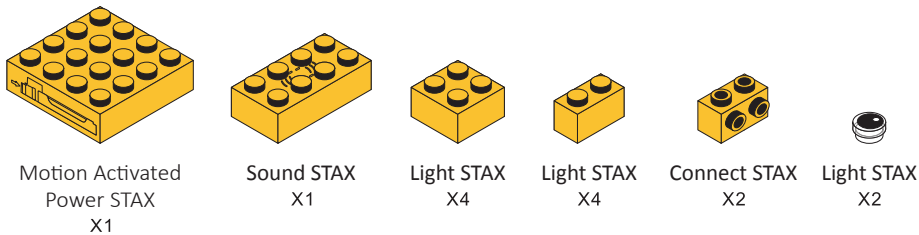

1-1

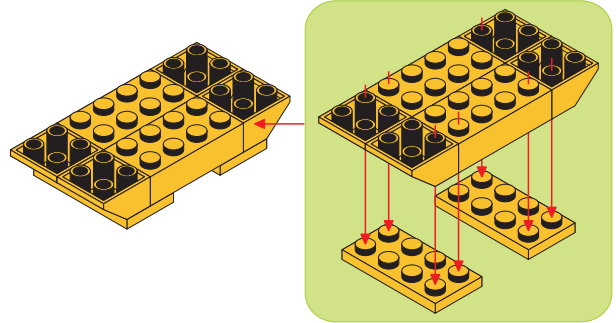
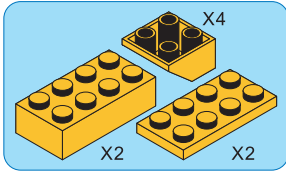

1-2

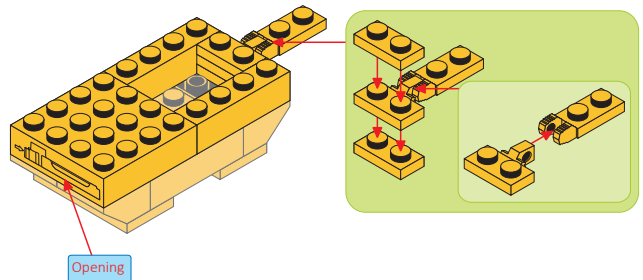
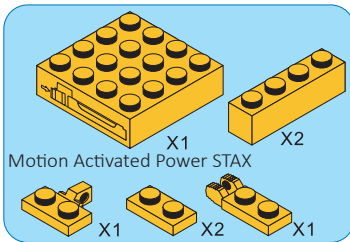

1-3

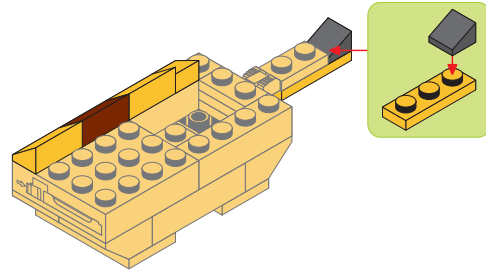
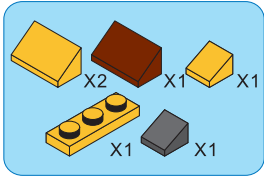

1-4

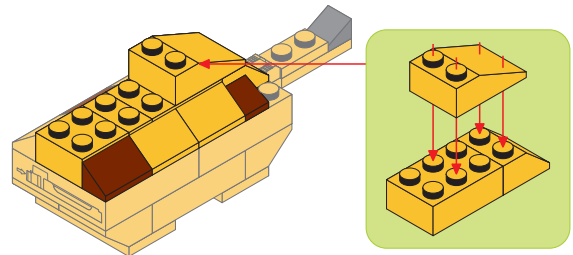
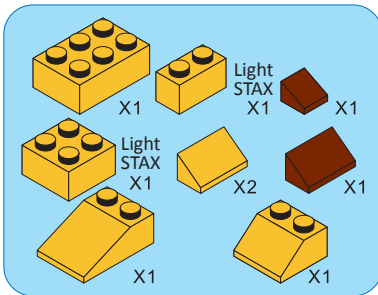

1-5

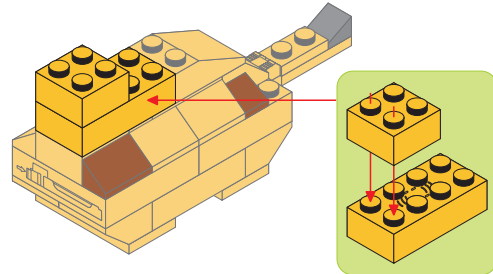
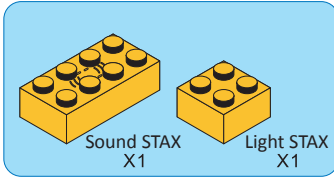

1-6

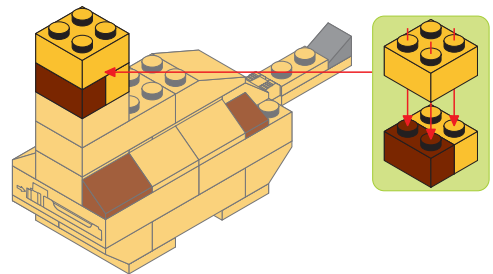
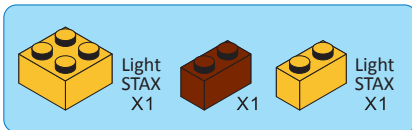

1-7

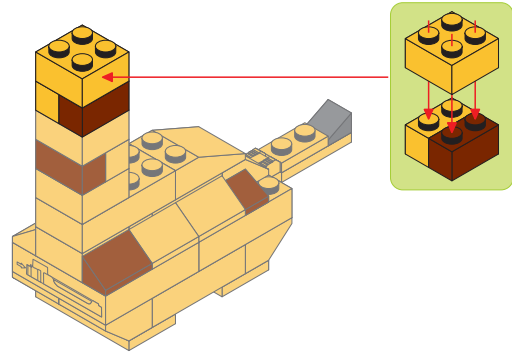
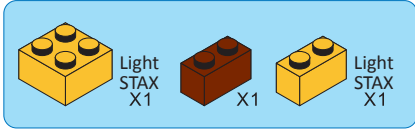

1-8

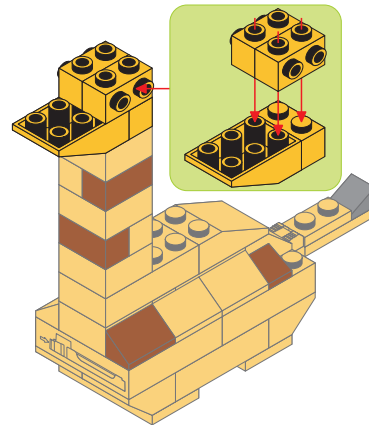

1-9

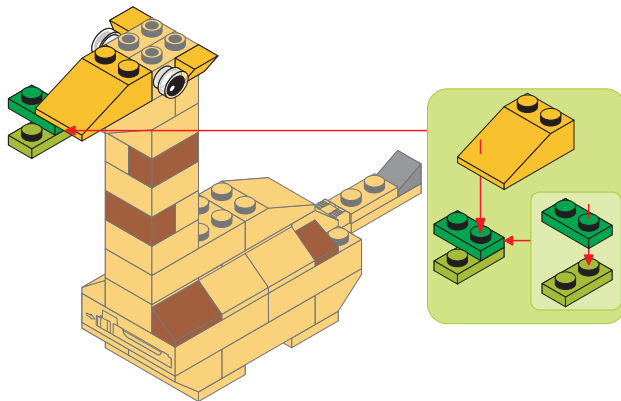
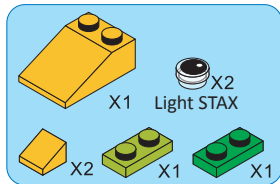

1-10

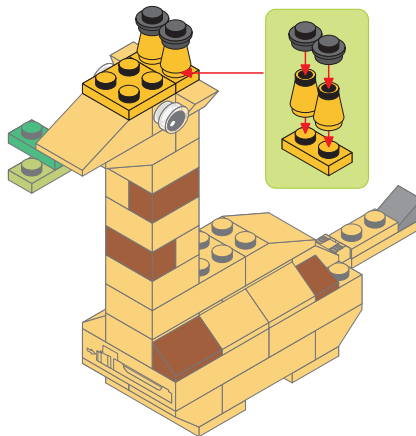
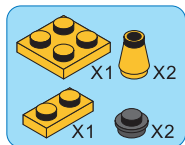

1-11

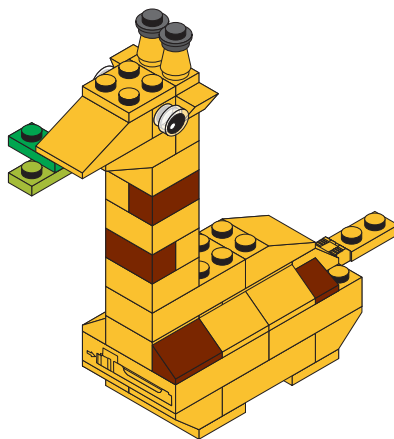

1-12

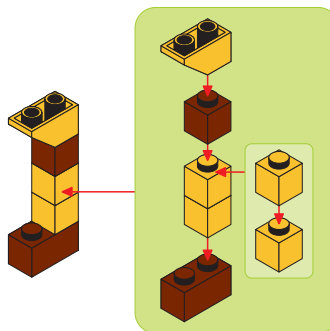
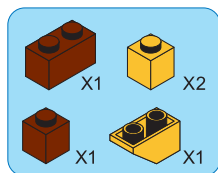

1-13

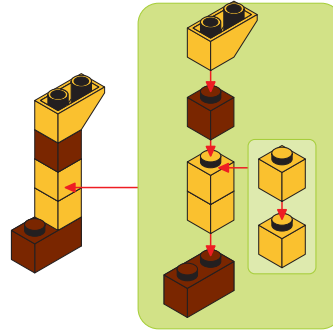
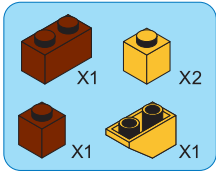

1-14

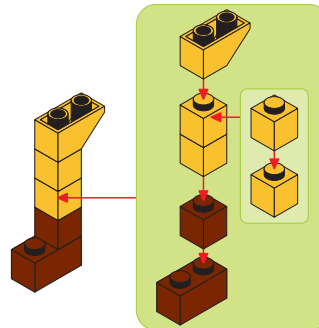
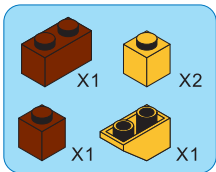

1-15

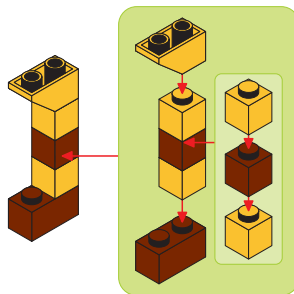
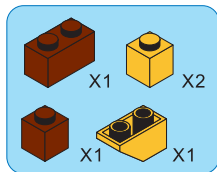

1-16

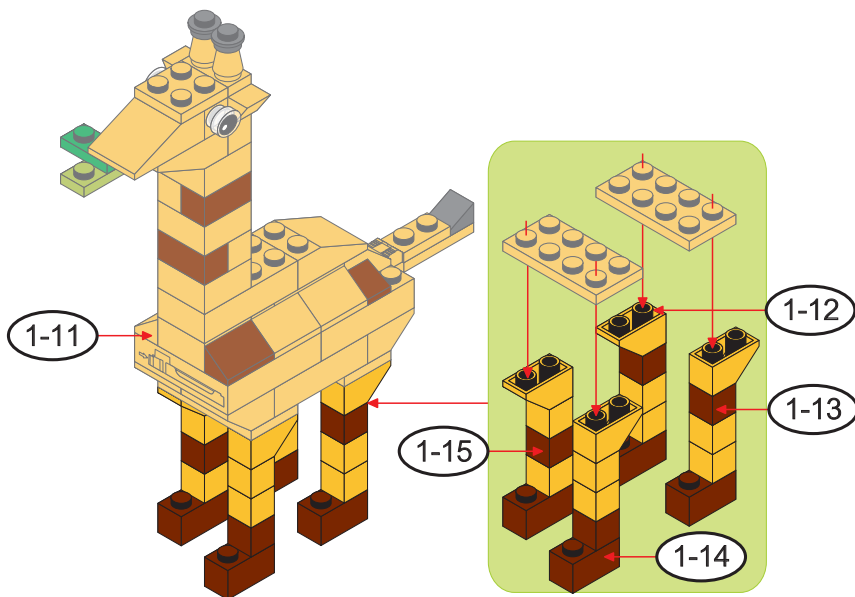

1-17

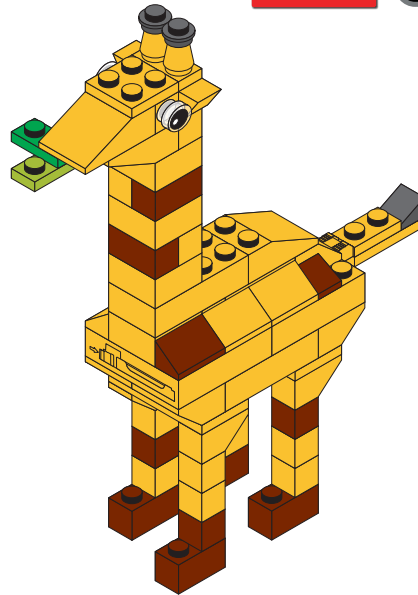

Special instructions:

1. To replace the CR2032 button cell battery, please see the 4x4 Motion Activated Power STAX Instruction manual.
2. As an upgrade, to avoid using batteries, we recommend replacing the button cell Power STAX with the rechargeable 4x4 Mobile Power STAX (Item# S-11503). You can purchase this from your STAX retailer or directly through our webshop at www.lightstax.eu!